

Saphireinschraubdüse 965



Eigenschaften und Vorteile

- Lange Lebensdauer
- Konstante Strahlqualität
- Stark gebündelter Wasserstrahl
- Punktstrahl mit hoher Energiedichte
- Einfache Installation und Demontage
- Swiss Quality

Anwendungen

- Automobil- und Luftfahrtindustrie
- Bauindustrie
- Bergbau
- Chemie
- Eisen-, Stahl- und Metallindustrie
- Energiewirtschaft
- Getränkeindustrie
- Glas-, Porzellan- und Keramikindustrie
- Holzindustrie
- Kommunalbetriebe
- Landwirtschaft
- Maschinen- und Apparatebau
- Nahrungsmittelindustrie
- Offshore-Einsätze
- Schiffbau
- Verkehrsbetriebe
- Zellstoff- und Papierindustrie
- Zement- und Betonindustrie

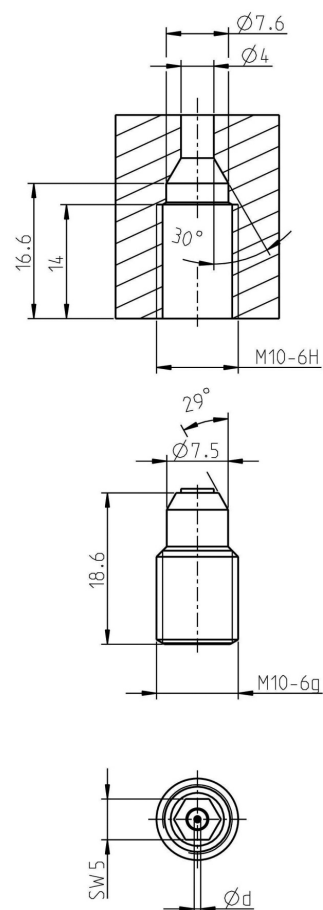

EIGENSCHAFTEN	Typ
	965
Betriebsdruck (bar)	max. 3000
Betriebstemperatur (°C)	max. 150°
Anzugsmoment (Nm)	max. 25

Leistungsdaten

ART. NR.	DÜSEN GRÖSSE in US Gal/min bei 40 psi	DÜSEN Ød mm	DRUCK in psi / bar							
			psi 2900	psi 7250	psi 10875	psi 14500	psi 21750	psi 29000	psi 36250	psi 43500
			bar 200	bar 500	bar 750	bar 1000	bar 1500	bar 2000	bar 2500	bar 3000
DURCHFLUSSMENGE in l/min										
32176.0100	0002	0.10	0.064	0.100	0.122	0.141	0.171	0.196	0.217	0.237
32176.0125	0003	0.125	0.100	0.157	0.191	0.220	0.267	0.306	0.340	0.370
32176.0150	0004	0.15	0.143	0.226	0.275	0.316	0.385	0.441	0.489	0.532
32176.0175	0006	0.175	0.195	0.307	0.375	0.431	0.523	0.600	0.666	0.725
32176.0200	0008	0.20	0.255	0.401	0.489	0.563	0.684	0.784	0.870	0.946
32176.0250	0012	0.25	0.402	0.632	0.771	0.887	1.078	1.235	1.371	1.492
32176.0300	0018	0.30	0.579	0.911	1.111	1.277	1.552	1.778	1.974	2.148
32176.0350	0025	0.35	0.808	1.270	1.549	1.781	2.165	2.481	2.754	2.997
32176.0400	0032	0.40	1.055	1.659	2.023	2.327	2.827	3.240	3.597	3.914
32176.0450	0041	0.45	1.339	2.106	2.568	2.953	3.588	4.112	4.565	4.968
32176.0500	0051	0.50	1.653	2.600	3.170	3.646	4.430	5.077	5.636	6.133
32176.0550	0062	0.55	2.008	3.159	3.853	4.430	5.383	6.169	6.849	7.453
32176.0600	0074	0.60	2.390	3.759	4.585	5.272	6.406	7.342	8.151	8.869
32176.0650	0087	0.65	2.813	4.425	5.396	6.205	7.540	8.641	9.593	10.438
32176.0700	0100	0.70	3.262	5.131	6.258	7.196	8.744	10.022	11.125	12.106
32176.0750	0115	0.75	3.745	5.891	7.184	8.261	10.038	11.504	12.772	13.897
32176.0800	0131	0.80	4.261	6.702	8.174	9.399	11.421	13.090	14.531	15.812
32176.0850	0150	0.85	4.878	7.673	9.357	10.761	13.075	14.985	16.635	18.102
32176.0900	0168	0.90	5.469	8.602	10.491	12.064	14.658	16.800	18.650	20.294
32176.0950	0192	0.95	6.254	9.837	11.997	13.796	16.763	19.212	21.328	23.208
32176.1000	0213	1.00	6.930	10.900	13.293	15.287	18.574	21.288	23.632	25.715
32176.1100	0258	1.10	8.397	13.207	16.107	18.522	22.505	25.793	28.634	31.158
32176.1200	0307	1.20	9.993	15.717	19.168	22.042	26.783	30.696	34.077	37.080
32176.1300	0361	1.30	11.728	18.446	22.496	25.869	31.433	36.025	39.993	43.518
32176.1400	0418	1.40	13.601	21.393	26.090	30.002	36.455	41.780	46.382	50.470
32176.1500	0480	1.50	15.614	24.558	29.950	34.441	41.849	47.962	53.245	57.938
32176.1600	0546	1.60	17.765	27.942	34.077	39.187	47.615	54.570	60.581	65.920
32176.1700	0617	1.70	20.055	31.544	38.470	44.238	53.753	61.605	68.390	74.418
32176.1800	0692	1.80	22.484	35.364	43.129	49.596	60.263	69.066	76.673	83.431
32176.1900	0771	1.90	25.051	39.402	48.054	55.259	67.144	76.953	85.428	92.958
32176.2000	0854	2.00	27.758	43.659	53.245	61.229	74.398	85.266	94.658	103.001
32176.2100	0941	2.10	30.603	48.134	58.703	67.505	82.024	94.006	104.360	113.558
32176.2200	1103	2.20	35.856	56.397	68.780	79.093	96.104	110.143	122.274	133.052
32176.2300	1205	2.30	39.190	61.641	75.175	86.447	105.040	120.384	133.643	145.422
32176.2400	1313	2.40	42.672	67.117	81.854	94.127	114.372	131.080	145.517	158.343
32176.2500	1424	2.50	46.302	72.827	88.817	102.135	124.102	142.230	157.896	171.813
32176.2600	1540	2.60	50.080	78.770	96.064	110.469	134.228	153.836	170.780	185.833
32176.2700	1661	2.70	54.007	84.945	103.596	119.130	144.752	165.898	184.170	200.402
32176.2800	1787	2.80	58.081	91.354	111.412	128.118	155.673	178.414	198.064	215.522
32176.2900	1916	2.90	62.304	97.996	119.512	137.432	166.991	191.385	212.465	231.191
32176.3000	2051	3.00	66.675	104.871	127.896	147.074	178.707	204.812	227.370	247.410

Anweisung

Beim manuellen Einsatz von Hockdruckspritzpistolen und -Lanzen, darf die aufzunehmende Rückstosskraft in der Längsachse der Spitzeinrichtung 250N nicht übersteigen!

Übersteigt die Rückstosskraft 150N, muss mit einer Körperstütze gearbeitet werden!

	< 150 N
	< 250 N
	> 250 N